

Lifting Capacities

Hydraulic Lattice Boom Truck Crane

HC-278H II 300-ton (272 metric ton)

HYLAB Series

Tube Boom Capacities

60 – 330' (18.29 – 100.58 m)

Tube Boom Capacities

- 60' – 330' (18.29 – 100.58 m) Open Throat Boom
- 80" (2.03 m) wide x 68" (1.73 m) Deep Boom
- On Fully Extended Outriggers
- 10' (3.05 m) Extension Lifting Capacities
- 360° Rotation and Over The Rear Capacities
- Counterweight options "ABCDE + AB", "ABCDE + A", "ABCDE + 0", "ABC + 0", "A + 0" and "0"

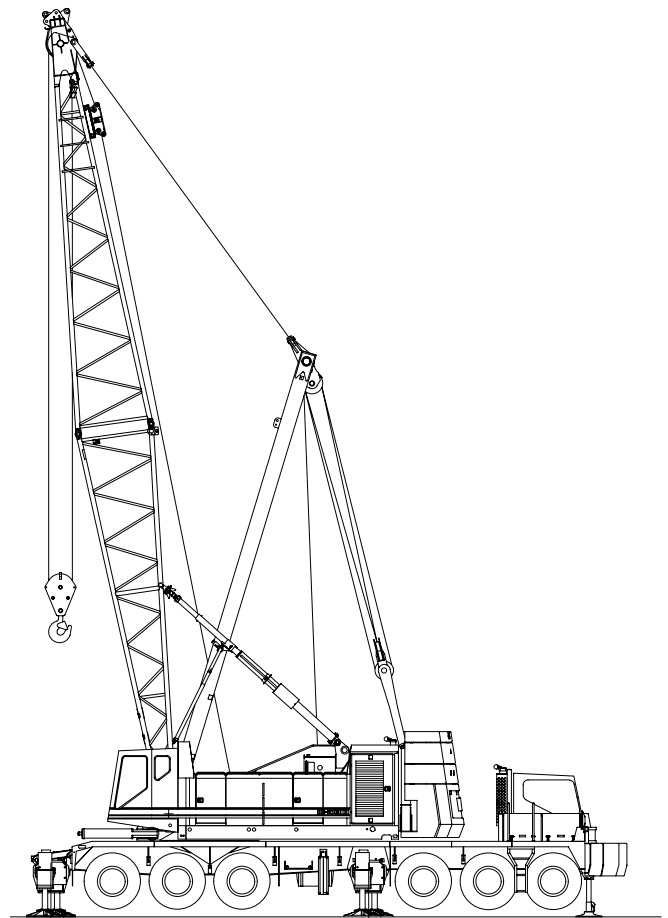

CAUTION: This material is supplied for reference use only. Operator must refer to in-cab Crane Rating Manual to determine allowable machine lifting capacities and operating procedures.



WARNING

ALWAYS READ AND UNDERSTAND THE OPERATOR'S AND SAFETY MANUALS AND THE FOLLOWING INSTRUCTIONS AND CHART VALUES BEFORE OPERATING ANY CRANE. OPERATION WHICH DOES NOT FOLLOW THESE INSTRUCTIONS MAY RESULT IN AN ACCIDENT. THIS DOCUMENT IS INTENDED FOR REFERENCE USE ONLY.

OPERATING INSTRUCTIONS

GENERAL:

1. This load represents the 10.4' (3.17m) radius duty equivalent of the maximum available load moment.
2. 625,000 lbs. (283 000 kg) at 12' (3.66 m) radius was the maximum static overload test performed per SAE J987.
3. Rated lifting capacities as shown on lift chart pertain to this crane as originally manufactured and normally equipped by Link-Belt Construction Equipment Company (LBCE). Modifications to the crane or use of optional equipment other than that specified can result in a reduction of capacity.
4. Construction equipment can be dangerous if improperly operated or maintained. Operation and maintenance of this crane must be in compliance with the information in the Operator's, Parts, and Safety manuals supplied with this crane. If the manuals are missing, order replacements through the distributor.
5. The operator and other personnel associated with this crane shall fully acquaint themselves with the latest applicable American National Standards Institute (ANSI) safety standards for cranes.
6. All capacities listed in this book are in compliance with SAE J987—April 1994 (Crane Structures—Method Of Test) and SAE J765a — October 1990 (Crane Load Stability Test).

LIFTING CRANE OPERATION:

1. Capacities shown are not more than 85% of the tipping loads on outriggers and 75% of the tipping loads on tires with crane standing level on firm supporting surface. A deduction must be made from these capacities for weight of hook block, hook ball, sling, grapple, load weighing devices, etc. When using main hook while jib is attached, reduce capacities by values shown on chart "Capacity Deductions For Lifting Off Main Boom Hook With Jib Installed." See Operator's Manual for all limitations when raising or lowering attachment.
2. When using main hook on Open Throat boom while jib is attached, reduce capacities by values shown on Capacity Deductions For Lifting Off Main Boom Hook With Jib Installed. When using main hook on Open Throat boom while tip extension is attached, reduce capacities by values shown on Capacity Deductions For Lifting Off Main Boom Hook With Tip Extension Installed. See Operator's Manual for all limitations when raising or lowering attachment.
3. The crane capacities in the shaded areas are based on structural strength. The crane capacities in the non-shaded areas are based on stability ratings.
4. For recommended reeving, parts of line, wire rope type, and wire rope inspection, see Wire Rope Capacity chart, Operator's Manual, and Parts Manual. Rated lifting capacities are based on correct reeving. Deduction must be made for excessive reeving. Any reeving over minimum required is considered excessive and must be accounted for when making lifts. Use Working Range Diagram to estimate the extra feet of wire rope included in reeving. Then consult Wire Rope Capacity chart to determine the weight per foot of wire rope type. Deduct this amount for each extra foot of wire rope before attempting to lift a load.
5. When lifting loads with the Luffing Jib Bridle Guide Rails installed on the boom extensions, reduce capacities by the value shown on "Capacity Deductions For Lifting Loads With Luffing Jib Bridle Guide Rails Installed On Boom Extensions".
6. The maximum outrigger pontoon reaction seen under any condition listed in this crane rating manual is 285,000 lb (314 psi).

7. "On outrigger" capacities require that all four outrigger beams be fully extended, all five jacks be extended until all tires are clear of the ground and crane be properly leveled on a firm supporting surface.
8. The least stable rated condition is over the side.
9. For boom lengths exceeding 240' the midpoint suspension pendants are required.
10. Do not lift or suspend a load from the main boom and boom tip extension or jib at the same time.
11. Do not swing over side until all four outrigger beams are fully extended, all five jacks are extended until all tires are clear of the ground, and crane is properly leveled on a firm supporting surface.
12. On tire capacities are restricted to a maximum travel speed of .5 m.p.h. The boom must be centered straight over the rear with swing lock engaged and the load must be restrained from swinging.
13. Load ratings in this Crane Rating Manual are based on freely suspended loads and make no allowances for such factors as the effect of ground conditions and operating speeds. The operator shall therefore reduce load ratings in order to take these conditions into account.
14. Rated lifting capacities do not account for the effects of wind on a suspended load or boom. Lifting capacities should be considered acceptable for wind speeds up to 20 m.p.h. and appropriately reduced for wind speeds greater than 20 m.p.h. Extreme caution should be used when lifting heavy loads or loads with large wind sail area under high wind conditions (over 20 m.p.h.). See Wind Restriction charts in this manual for appropriate capacity reductions.
15. The 35' live mast must be used for all capacities.
16. These capacities apply only to the crane as originally manufactured and normally equipped by Link-Belt Construction Equipment Company.
17. Do not operate at radii and boom lengths where the Crane Rating Manual lists no capacity. Do not use longer booms or jibs than those listed in this Crane Rating Manual. Any of the above can cause a tipping condition, or boom and jib failure.
18. Open throat booms should be erected and lowered over the end for maximum stability. Consult the proper liftoff chart in this manual before erecting or lowering open throat booms.
19. For boom lengths up to and including 220', "J", "JE", or "JN" (.375" Wall) boom extensions must be used. 220' of boom includes a 30' base section, 160' of extensions, and a 30' top section. Extensions added beyond the first 160' of extensions must be "H" or "HJ" (.259" Wall) boom extensions.

DEFINITIONS:

1. Load Radius: Horizontal distance from a projection of the axis of rotation to the supporting surface, before loading, to the center of the vertical hoist line or tackle with load applied.
2. Boom Angle: The angle between the boom base section and horizontal with freely suspended load at the rated radius.
3. Working Area: Area measured in a circular arc about the centerline of rotation as shown on the Working Area Diagram.
4. Freely Suspended Load: Load hanging free with no direct external force applied except by the hoist line.
5. Side Load: Horizontal side force applied to the lifted load either on the ground or in the air.

WIRE ROPE CAPACITY

Parts of Line	1"			
	Type DB	Type CC	Type LB	Type RB
1	29,500	30,700	32,500	22,700*
2	59,000	61,400	65,000	45,400
3	88,500	92,100	97,500	68,100
4	118,000	122,800	130,000	90,800
5	147,500	153,500	162,500	113,500
6	177,000	184,200	195,000	136,200
7	206,500	214,900	227,500	158,900
8	236,000	245,600	260,000	181,600
9	265,500	276,300	292,500	204,300
10	295,000	307,000	325,000	227,000
11	324,500	337,700	357,500	249,700
12	354,000	368,400	390,000	272,400
Weight (lb/ft)	1.85	2.03	1.85	2.00

Parts of Line	1-1/8"					(28 mm)
	Type DB	Type ZB	Type LB	Type RB	Type SB	
1	37,100	35,300	40,800	28,600	52,400	
2	74,200	70,600	81,600	57,200	104,800	
3	111,300	105,900	122,400	85,800	157,200	
4	148,400	141,200	163,200	114,400	209,600	
5	185,500	176,500	204,000	143,000	262,000	
6	222,600	211,800	244,800	171,600	314,400	
7	259,700	247,100	285,600	200,200	366,800	
8	296,800	282,400	326,400	228,800	419,200	
9	333,900	317,700	367,200	257,400	471,600	
10	371,000	353,000	408,000	286,000	524,000	
11	408,100	388,300	448,800	314,600	576,400	
12	445,200	423,600	489,600	343,200	628,800	
Weight (lb/ft)	2.34	2.58	2.34	2.50	2.57	

LBCE Type	Description
DB	6 x 26 (6 x 19 Class), Warrington Seale, Extra Improved Plow Steel, Preformed, Right Lay – Regular Lay, I.W.R.C.
ZB	36 x 7 Non-Rotating, Extra Improved Plow Steel, Right Lay – Regular Lay, Compacted
LB	6 Strand, Compacted Strand, Seale or Warrington Seale, I.W.R.C., Preformed, Right Lay – Regular Lay
RB	19 x 19 Rotation Resistant, High Strength, Preformed – Right Lay – Regular Lay. Swaged
CC	36 x 7 Classification Non-Rotating – Extra Extra Improved Plow Steel, Right Lay – Regular Lay, Compact Strand
SB	8 Strand, Preformed – Right Lay Regular Lay

Notes:

- Capacities shown are in pounds and working loads must not exceed the ratings on the capacity chart in the Crane Rating Manual.
- Study Operator's Manual for wire rope inspection procedures.

WORKING AREAS

Carrier On Outriggers

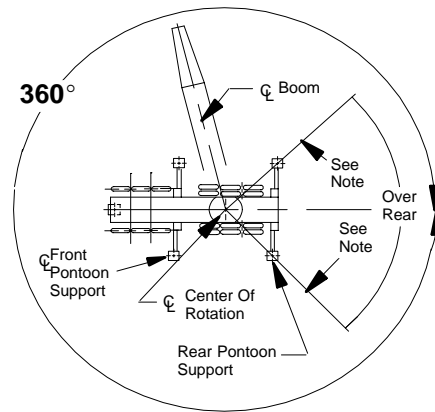

Carrier On Tires

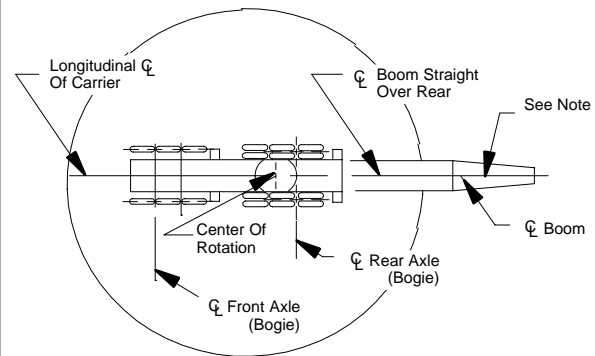

Note:

- These Lines Determine The Limiting Position Of Any Load For Operation Within Working Areas Indicated.

ALLOWABLE COUNTERWEIGHTS

Counterweight Combinations (1) Upper + Bumper	Allowable open throat boom lengths	
	w/o Jib (ft)	With Jib (ft) (3)
0 + 0 on outriggers	60–190	PROHIBITED
A + 0 on outriggers (2)	60–220	
ABC + 0 on outriggers (2)	60–270	
ABCDE + 0 on outriggers (2)	60–300	60–260
ABCDE + A on outriggers (2)	60–320	PROHIBITED
ABCDE + AB on outriggers (2)	60–330	60–300

Notes:

- Counterweight combinations are for a crane equipped with a 250 ton open throat boom. Counterweight combinations must be used only as shown on this chart, otherwise crane may overturn or other damage may occur.
- "A" Upper Counterweight – 30,000 lbs.
"ABC" Upper Counterweight – 76,700 lbs.
"ABCDE" Upper Counterweight – 108,000 lbs.
"A" Bumper Counterweight – 11,400 lbs.
"AB" Bumper Counterweight – 26,700 lbs.
- Do not swing over the side until outrigger beams are fully extended and outrigger jacks set with upper counterweights, or crane may overturn.
- Maximum jib length is 100 ft.

CRANE ASSEMBLY COMPONENT WEIGHTS

Component	Weight	
	lb	kg
1. 30' Base Section Assembly	4,912	2 228
– 3rd Drum Assembly	2,857	1 296
– 3rd Drum Fleeting Sheave Assembly	850	386
– 3rd Drum Rope (970' of 1" type "RB")	1,940	880
2. 30' Top Section with 6 Sheave Machinery Assy.	5,612	2 546
3. Boom Extensions		
– 10' "J" Boom Extension Assembly	1,150	521
– 10' "JN" Boom Extension Assembly	1,617	733
– 10' "JE" Boom Ext. w/ Lifting Sheaves Assembly	3,251	1 475
– 20' "J" Boom Extension Assembly	2,000	907
– 20' "JE" Boom Extension Assembly	2,514	1 140
– 30' "J" Boom Extension Assembly	2,800	1 270
– 30' "JE" Boom Extension Assembly	3,454	1 567
– 40' "JE" Boom Extension Assembly	4,567	2 072
– 50' "JE" Boom Extension Assembly	5,567	2 525
– 10' "H" or "HJ" Boom Extension Assembly	1,382	627
– 20' "H" or "HJ" Boom Extension Assembly	2,163	981
– 30' "H" or "HJ" Boom Extension Assembly	2,940	1 334
– 40' "H" or "HJ" Boom Extension Assembly	3,761	1 692
– 50' "H" or "HJ" Boom Extension Assembly	4,538	2 045
4. Front Outrigger Assembly	12,760	5 788
5. Rear Outrigger Assembly	12,760	5 788
6. Upper Counterweights		
– Counterweight "A"	30,000	13 608
– Counterweight "B"	25,000	11 340
– Counterweight "C"	21,500	9 752
– Counterweight "D"	21,500	9 752
– Counterweight "E"	10,000	4 536
– Counterweight "AB"	55,000	24 948
– Counterweight "ABC"	76,500	34 700
– Counterweight "ABCD"	98,000	44 453
– Counterweight "ABCDE"	108,000	48 989
7. Bumper Counterweights		
– Counterweight "A"	11,400	5 171
– Counterweight "B"	15,300	6 940
– Counterweight "AB"	26,700	12 111

GENERAL WIND RESTRICTIONS GUIDE

When operating a Link-Belt lattice boom crane under high wind conditions (over 20 m.p.h.), the following chart may be used as a guide to reduce capacities for emergency one time lifts for any boom length up to 250 feet.

If the wind velocity exceeds	All crane capacities must be reduced
20 m.p.h.	20%
30 m.p.h.	40%
40 m.p.h.	70%
45 m.p.h.	Crane operation must be shut down and the boom lowered to the ground.

HC-278H II WIND RESTRICTIONS

When operating a Link-Belt HC-278H II lattice boom crane under high wind conditions (over 20 m.p.h.), the following chart may be used as a guide to reduce capacities for emergency one time lifts for any boom length from 260 through 330 feet. For boom lengths up to and including 250 feet, use the Link-Belt General Wind Restrictions guide.

If the wind Velocity exceeds	All crane capacities must be reduced
20 m.p.h.	35%
30 m.p.h.	60%
40 m.p.h.	80%
45 m.p.h.	Crane operation must be shut down and the boom lowered to the ground.

NOTES:

1. The restrictions do not take into account the effect of wind acting on the load. Additional reductions in capacity are required for loads with large wind sail area.
2. Operator judgment must be the final consideration as to when the wind conditions jeopardize good operating practices.

LIFTOFF CAPABILITIES ON OUTRIGGERS

Counterweight (upper + bumper)	Max Boom		Maximum Boom + Jib	
	Over Side (ft)	Over Rear (ft)	Over Side (ft)	Over Rear (ft)
0+0	170	190	PROHIBITED	
A+0	210	220		
ABC+0	260	270		
ABCDE+0	290	300	250+100	260+100
ABCDE+A	290	320	PROHIBITED	
ABCDE+AB	300	330	260+100	300+100

***NOTES:**

1. 95% of available crane stability.
2. Machine on firm and level surface.

LIFTOFF CAPABILITIES ON TIRES OVER THE REAR

Counterweight (upper+bumper)	Boom (ft)	Boom + Jib (ft)
0+0	100	PROHIBITED
A+0	140	
ABC+0	170	
ABCDE+0	200	160+100
ABCDE+A	210	PROHIBITED
ABCDE+AB	230	200+100

*** NOTES:**

1. 95% of available crane stability.
2. Machine on firm and level surface.

LIVE MAST LIFTING CAPACITIES

Mast Radius	CAPACITY (No Counterweight)	
	On Tires	On Outriggers
12' – 17'	55,000 lbs.	76,500 lbs.
17' – 28'	30,000 lbs.	76,500 lbs.

⚠ CAUTION

1. Refer to Operator's Manual.
2. Live mast backstops must be in position and operative.
3. Use rear drum only. Reeve hoist line to drum over mast cross member. Reeve hoist rope with three (3) parts of 1.00", 1-1/8" (28.5 mm) diameter wire rope.
4. 76,500 lbs. capacity is based on strength of material.
5. Refer to "Crane Assembly Component Weights" for weight of components when lifting from live mast.

10' EXT. LIFTING CAPACITIES – 360°

Load Radius (ft)	Boom Angle (deg)	On Tires Without Ctwrt (lb)	On Outriggers With/Without Ctwrt (lb)
10.31	82.0	55,000	76,500
11	80.9	55,000	76,500
12	79.3	55,000	76,500
13	77.6	55,000	76,500
14	75.9	55,000	76,500
15	74.3	55,000	76,500
16	72.6	52,400	76,500
17	70.9	49,600	76,500
18	69.1	47,000	76,500
19	67.4	44,700	76,500
20	65.6	42,500	76,500
21	63.8	40,500	76,500
22	61.9	38,600	76,500
23	60.1	36,200	76,500
24	58.1	34,000	76,500
25	56.2	32,000	76,500
26	54.1	30,100	76,500
27	52.1	28,500	76,500
28	49.9	27,000	76,500
29	47.7	25,600	76,500
30	45.4	24,300	76,500
31	42.9	23,100	76,500
32	40.3	21,900	76,500
33	37.6	20,900	76,500
34	34.7	19,900	75,000
35	31.5	19,000	70,800
36	27.9	18,100	66,900

⚠ CAUTION

1. Refer to operator's manual.
2. Use front drum only. Reeve hoist line under mast cross member.
3. Reeve hoist rope with three (3) parts of 1.125" or 1.00" diameter wire rope. See operator's manual for correct procedure.
4. Do not swing upper when crane is on tires and upper equipped with "A", "AB", "ABC", "ABCD", OR "ABCDE" counterweights.
5. Refer to "Crane assembly component weights" for weights of components when lifting with the 10' extension.
6. 10' extension capacities are restricted to crane assembly/disassembly. Do not lift loads with 10' extension for any reason other than crane assembly/disassembly.

WORKING RANGE DIAGRAM

60' TO 330' MAIN BOOM ON OUTRIGGERS

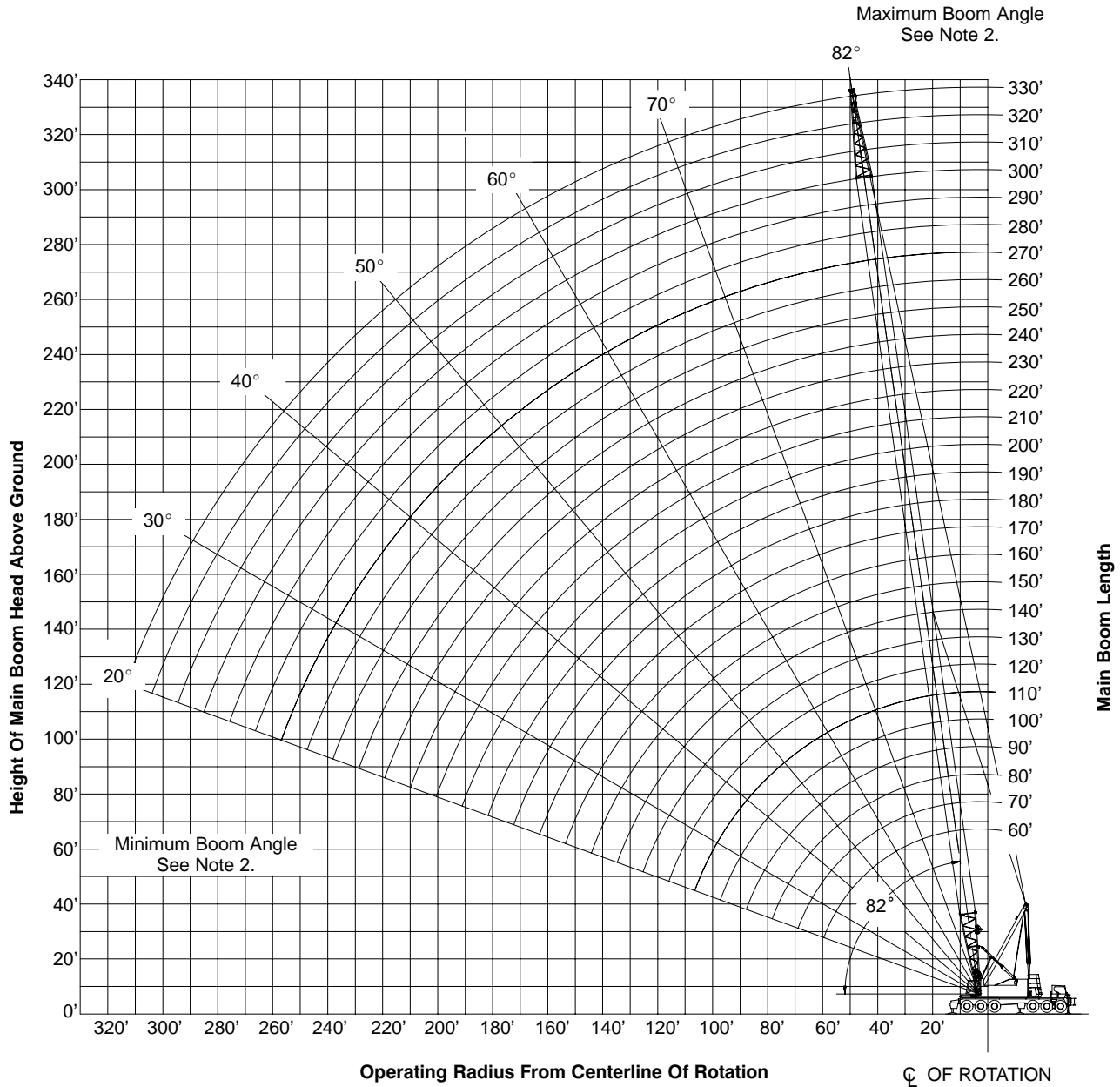

Notes:

1. Boom geometry shown is for unloaded condition and crane standing level on firm supporting surface. Boom deflection, subsequent radius and boom angle change must be accounted for when applying load to hook.
2. Maximum and minimum boom angles are equal to the values listed in the capacity chart for each boom length.

CAPACITY DEDUCTIONS FOR LIFTING OFF MAIN BOOM HOOK WITH JIB INSTALLED

When using main boom hook, while jib is attached, reduce boom capacities by the values in the following chart:

Jib Length (ft)	Capacity Deduction (lbs)
30'	2,600
40'	3,000
50'	3,400
60'	3,800
70'	4,200
80'	4,600
90'	5,000
100'	5,400

CAPACITY DEDUCTIONS FOR LIFTING OFF MAIN BOOM HOOK WITH TIP EXTENSION INSTALLED

When using main boom hook, while tip extension is attached, reduce boom capacities by the value in the following chart:

Tip Extension	Capacity Deduction (lb)
	1,100

CAPACITY DEDUCTIONS FOR LIFTING LOADS WITH LUFFING JIB BRIDLE GUIDE RAILS INSTALLED ON BOOM EXTENSIONS

When using main boom hook or the jib hook, while the luffing jib guide rails are installed, reduce boom capacities by the value in the following chart:

Guide Rails (60')	Capacity Deduction (lb)
	1,000

MAXIMUM ALLOWABLE CAPACITIES FOR TIP EXTENSION

LIFTING CAPACITY TO BE THE SMALLEST OF THE FOLLOWING VALUES:

- 50,000 lb (Maximum).
- The standard crane lift capacity minus 1,100 lb for the boom length, tip extension load radius, and counterweight configuration in use on the crane.

NOTES:

- All notes are to be adhered to as listed on the standard lift crane capacity charts .
- Reduce the main boom lift capacities by 1,100 lb when the tip extension is installed.
- The maximum boom length on which the tip extension can be installed is 300'.
- Do not lift or suspend a load from the boom tip extension and main boom at the same time.

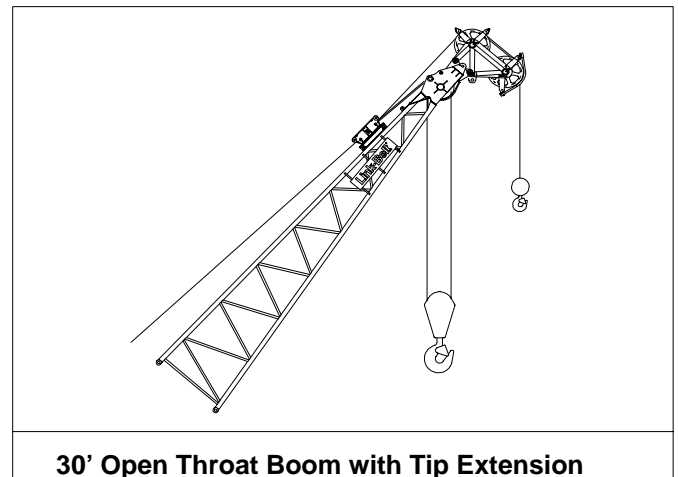

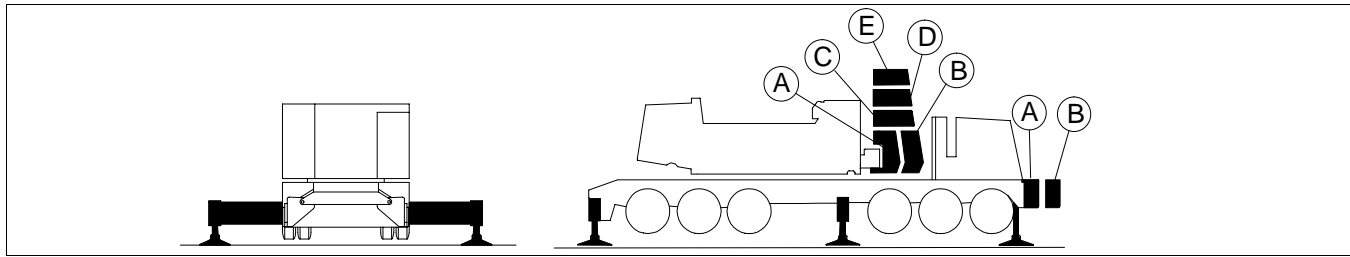

Main Boom Capacities – On Outriggers – 60 Ft Open Throat Tube Boom

Load Radius (ft)	Boom Angle (deg)	Counterweight Combinations – Upper + Bumper								
		Over The Rear			360 Degree Rotation					
		ABCDE+0	ABCDE+A	ABCDE+AB	0+0	A+0	ABC+0	ABCE+0	ABCDE+A	ABCDE+AB
10.4 *	—	600,000 *	600,000 *	600,000 *	—	—	—	—	—	—
12	81.5	500,000	500,000	500,000	380,700	398,100	417,500	429,200	412,800	390,400
13	80.6	438,200	441,800	441,800	351,700	379,600	398,300	409,400	393,900	372,400
14	79.6	418,800	422,400	422,400	326,600	362,200	380,700	391,400	376,400	356,000
15	78.6	401,200	404,800	404,800	304,800	338,000	364,600	374,800	360,600	340,900
16	77.6	384,800	388,400	388,400	285,600	316,900	349,700	359,600	345,800	326,900
17	76.7	368,200	368,200	368,200	268,700	298,100	335,800	345,400	332,200	314,100
18	75.7	347,700	347,700	347,700	253,500	281,400	323,400	332,400	319,800	302,300
19	74.7	329,400	329,400	329,400	240,100	266,400	308,500	320,900	308,500	291,600
20	73.7	312,900	312,900	312,900	227,800	252,800	292,900	310,200	298,200	282,000
25	68.7	250,300	250,300	250,300	152,400	201,300	233,500	250,300	250,300	243,000
30	63.4	208,600	208,600	208,600	107,200	149,600	193,500	208,600	208,600	207,500
35	58.0	178,800	178,800	178,800	81,800	115,000	164,700	178,800	178,800	178,800
40	52.1	156,200	156,200	156,200	65,700	92,800	135,700	156,200	156,200	156,200
50	38.7	122,800	122,800	122,800	46,100	66,100	97,600	118,200	121,400	122,800
60	18.7	90,300	90,300	90,300	34,600	50,400	75,400	90,300	90,300	90,300

* – See note 1 under General Notes on page 2.

Main Boom Capacities – On Outriggers – 70 Ft Open Throat Tube Boom

Load Radius (ft)	Boom Angle (deg)	Counterweight Combinations – Upper + Bumper								
		Over The Rear			360 Degree Rotation					
		ABCDE+0	ABCDE+A	ABCDE+AB	0+0	A+0	ABC+0	ABCE+0	ABCDE+A	ABCDE+AB
12.91	82.0	438,700	442,300	442,300	353,400	380,100	398,800	409,800	394,200	372,700
13	81.9	436,900	440,500	440,500	351,000	378,500	397,100	408,100	392,600	371,100
14	81.1	417,600	421,200	421,200	325,900	361,400	379,600	390,300	375,300	354,900
15	80.3	400,100	403,700	403,700	304,300	337,300	363,600	373,700	359,500	339,800
16	79.4	383,800	387,400	387,400	285,100	316,300	348,700	358,600	344,800	325,900
17	78.6	368,200	368,200	368,200	268,300	297,500	335,000	344,500	331,300	313,300
18	77.8	347,700	347,700	347,700	253,100	281,000	322,600	331,600	319,000	301,500
19	76.9	329,400	329,400	329,400	239,700	266,000	308,000	320,100	307,700	290,800
20	76.1	312,900	312,900	312,900	227,500	252,400	292,400	309,400	297,500	281,200
25	71.8	250,300	250,300	250,300	153,200	201,000	233,100	250,300	250,300	242,400
30	67.5	208,600	208,600	208,600	107,800	150,200	193,200	208,600	208,600	207,200
35	63.0	178,800	178,800	178,800	82,200	115,400	164,500	178,800	178,800	178,800
40	58.3	154,700	154,700	154,700	66,000	93,100	136,000	154,700	154,700	154,700
50	48.0	118,600	118,600	118,600	46,300	66,300	97,800	118,400	118,600	118,600
60	35.7	93,800	93,800	93,800	34,900	50,600	75,600	91,800	93,800	93,800
70	17.3	75,500	75,500	75,500	27,300	40,400	61,000	74,500	75,500	75,500

Main Boom Capacities – On Outriggers – 80 Ft Open Throat Tube Boom

Load Radius (ft)	Boom Angle (deg)	Counterweight Combinations – Upper + Bumper								
		Over The Rear			360 Degree Rotation					
		ABCDE+0	ABCDE+A	ABCDE+AB	0+0	A+0	ABC+0	ABCE+0	ABCDE+A	ABCDE+AB
14.3	82.0	410,800	414,400	414,400	318,400	352,800	373,300	383,800	369,000	349,000
15	81.5	398,800	402,400	402,400	303,500	336,400	362,400	372,400	358,300	338,600
16	80.8	382,600	386,200	386,200	284,400	315,500	347,600	357,500	343,700	325,000
17	80.0	367,600	368,200	368,200	267,600	296,800	333,900	343,400	330,200	312,200
18	79.3	347,700	347,700	347,700	252,500	280,300	321,600	330,500	318,000	300,500
19	78.6	329,400	329,400	329,400	239,200	265,400	307,300	319,100	306,800	289,900
20	77.9	312,900	312,900	312,900	227,000	251,900	291,700	308,500	296,600	280,400
25	74.2	250,300	250,300	250,300	153,700	200,600	232,600	250,300	250,300	241,700
30	70.4	207,900	207,900	207,900	108,100	150,500	192,800	207,900	207,900	206,800
35	66.6	173,700	173,700	173,700	82,400	115,600	164,100	173,700	173,700	173,700
40	62.6	148,900	148,900	148,900	66,200	93,200	136,000	148,900	148,900	148,900
50	54.2	114,600	114,600	114,600	46,300	66,400	97,800	114,600	114,600	114,600
60	44.7	91,200	91,200	91,200	35,000	50,600	75,600	91,200	91,200	91,200
70	33.3	75,100	75,100	75,100	27,400	40,400	61,000	74,500	75,100	75,100
80	16.2	61,300	61,300	61,300	22,000	33,100	50,700	61,300	61,300	61,300

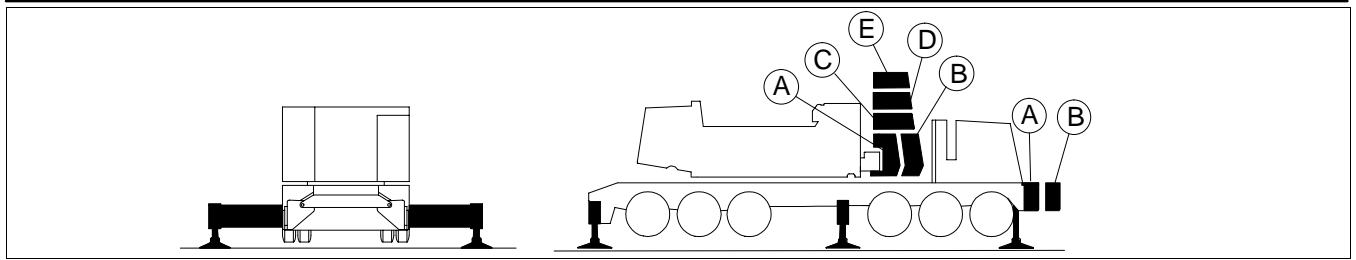

Main Boom Capacities – On Outriggers – 90 Ft Open Throat Tube Boom										
Load Radius (ft)	Boom Angle (deg)	Counterweight Combinations – Upper + Bumper								
		Over The Rear			360 Degree Rotation					
		ABCDE+0	ABCDE+A	ABCDE+AB	0+0	A+0	ABC+0	ABCDE+0	ABCDE+A	ABCDE+AB
15.69	82.0	387,100	390,700	390,700	290,700	322,300	351,800	361,700	347,700	328,600
16	81.8	382,200	385,900	385,900	285,000	316,100	347,400	357,200	343,400	324,700
17	81.2	367,300	368,200	368,200	268,300	297,400	333,700	343,200	329,900	312,000
18	80.5	347,700	347,700	347,700	253,200	280,900	321,400	330,300	317,800	300,300
19	79.9	329,400	329,400	329,400	239,800	265,900	307,700	318,900	306,600	289,700
20	79.2	312,900	312,900	312,900	227,600	252,400	292,200	308,300	296,400	280,200
25	76.0	250,300	250,300	250,300	155,900	201,000	233,000	250,300	250,300	241,600
30	72.7	208,600	208,600	208,600	109,600	151,900	193,200	208,600	208,600	207,100
35	69.3	178,800	178,800	178,800	83,500	116,700	164,400	178,800	178,800	178,800
40	65.8	155,800	155,800	155,800	67,000	94,000	136,900	155,800	155,800	155,800
50	58.6	122,800	122,800	122,800	46,900	66,900	98,300	119,000	121,900	122,800
60	50.8	100,200	100,800	100,800	35,400	51,000	76,000	92,200	94,600	98,000
70	42.0	81,200	85,000	85,000	27,700	40,600	61,300	74,800	76,800	79,600
80	31.4	68,000	73,200	73,200	22,200	33,400	50,800	62,400	64,100	66,500
90	15.2	58,000	63,300	63,800	18,100	27,800	43,100	53,100	54,600	56,700

Main Boom Capacities – On Outriggers – 100 Ft Open Throat Tube Boom										
Load Radius (ft)	Boom Angle (deg)	Counterweight Combinations – Upper + Bumper								
		Over The Rear			360 Degree Rotation					
		ABCDE+0	ABCDE+A	ABCDE+AB	0+0	A+0	ABC+0	ABCDE+0	ABCDE+A	ABCDE+AB
17.08	82.0	365,000	366,400	366,400	266,100	295,000	331,400	340,800	327,600	309,700
18	81.5	347,700	347,700	347,700	252,400	280,100	320,300	329,100	316,600	299,100
19	80.9	329,400	329,400	329,400	239,100	265,100	306,800	317,800	305,500	288,600
20	80.3	312,900	312,900	312,900	226,900	251,600	291,300	307,300	295,300	279,200
25	77.4	250,300	250,300	250,300	156,200	200,500	232,400	250,300	250,300	240,800
30	74.4	208,600	208,600	208,600	109,700	152,000	192,600	208,600	208,600	206,500
35	71.4	178,600	178,600	178,600	83,500	116,700	163,800	178,600	178,600	178,600
40	68.4	155,300	155,300	155,300	67,000	94,000	136,800	155,300	155,300	155,300
50	62.1	122,300	122,300	122,300	46,800	66,800	98,200	118,900	121,800	122,300
60	55.4	100,000	100,400	100,400	35,300	50,900	75,900	92,000	94,500	97,800
70	48.1	81,200	84,600	84,600	27,500	40,400	61,100	74,600	76,700	79,400
80	39.8	67,900	72,800	72,800	22,100	33,200	50,700	62,200	63,900	66,300
90	29.7	57,900	63,200	63,500	18,000	27,700	42,900	53,000	54,500	56,500
100	14.5	50,200	54,900	56,000	14,800	23,400	37,000	45,800	47,200	49,000

Main Boom Capacities – On Outriggers – 110 Ft Open Throat Tube Boom										
Load Radius (ft)	Boom Angle (deg)	Counterweight Combinations – Upper + Bumper								
		Over The Rear			360 Degree Rotation					
		ABCDE+0	ABCDE+A	ABCDE+AB	0+0	A+0	ABC+0	ABCDE+0	ABCDE+A	ABCDE+AB
18.48	82.0	338,700	338,700	338,700	244,900	271,800	313,700	322,500	310,000	292,800
19	81.7	329,400	329,400	329,400	238,300	264,200	305,800	316,700	304,300	287,400
20	81.2	312,900	312,900	312,900	226,100	250,800	290,300	306,200	294,200	278,100
25	78.6	250,300	250,300	250,300	156,400	199,800	231,600	250,300	250,300	239,900
30	75.9	208,600	208,600	208,600	109,800	152,100	192,000	208,600	208,600	205,800
35	73.2	178,000	178,000	178,000	83,500	116,700	163,200	178,000	178,000	178,000
40	70.4	154,800	154,800	154,800	66,900	93,900	136,600	154,800	154,800	154,800
50	64.8	121,800	121,800	121,800	46,600	66,600	98,000	118,700	121,600	121,800
60	58.9	99,800	99,900	99,900	35,100	50,700	75,700	91,800	94,200	97,600
70	52.6	81,000	84,100	84,100	27,300	40,400	60,900	74,400	76,400	79,200
80	45.7	67,600	72,400	72,400	21,900	33,000	50,500	62,000	63,700	66,100
90	37.9	57,700	63,000	63,100	17,800	27,500	42,700	52,700	54,300	56,300
100	28.3	50,000	54,700	55,700	14,600	23,200	36,900	45,600	47,000	48,800
110	13.8	43,800	48,000	49,400	12,100	19,800	32,000	40,000	41,100	42,700

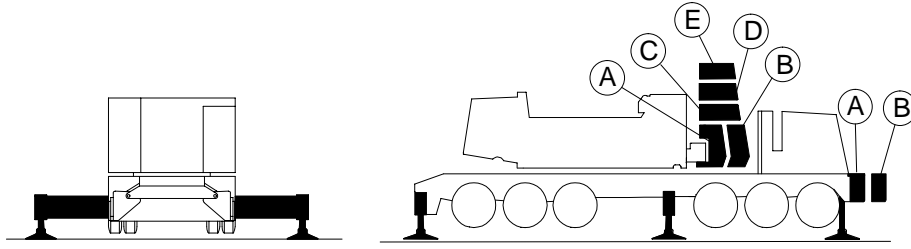

Main Boom Capacities – On Outriggers – 120 Ft Open Throat Tube Boom

Load Radius (ft)	Boom Angle (deg)	Counterweight Combinations – Upper + Bumper								
		Over The Rear			360 Degree Rotation					
		ABCDE+0	ABCDE+A	ABCDE+AB	0+0	A+0	ABC+0	ABCDE+0	ABCDE+A	ABCDE+AB
19.87	82.0	314,500	314,500	314,500	226,800	251,600	291,300	306,300	294,300	278,200
20	81.9	312,900	312,900	312,900	225,300	249,900	289,300	305,000	293,100	277,000
25	79.5	250,300	250,300	250,300	156,600	199,100	230,900	250,300	250,300	239,000
30	77.1	208,100	208,100	208,100	109,800	152,000	191,300	208,100	208,100	205,100
35	74.6	177,400	177,400	177,400	83,400	116,600	162,600	177,400	177,400	177,400
40	72.1	154,200	154,200	154,200	66,800	93,700	136,500	154,200	154,200	154,200
50	67.0	121,500	121,500	121,500	46,400	66,400	97,800	118,500	121,500	121,500
60	61.7	99,400	99,400	99,400	34,900	50,400	75,400	91,500	94,000	97,300
70	56.2	80,800	83,600	83,600	27,100	40,200	60,600	74,100	76,200	78,900
80	50.2	67,300	72,000	72,000	21,600	32,800	50,200	61,700	63,400	65,800
90	43.6	57,400	62,700	62,700	17,600	27,300	42,400	52,400	54,000	56,000
100	36.2	49,700	54,400	55,200	14,400	23,000	36,600	45,300	46,700	48,500
110	27.1	43,600	47,800	49,200	11,900	19,600	31,800	39,800	40,900	42,500
120	13.2	38,600	42,400	43,200	9,800	16,800	27,800	35,100	36,200	37,700

Main Boom Capacities – On Outriggers – 130 Ft Open Throat Tube Boom

Load Radius (ft)	Boom Angle (deg)	Counterweight Combinations – Upper + Bumper								
		Over The Rear			360 Degree Rotation					
		ABCDE+0	ABCDE+A	ABCDE+AB	0+0	A+0	ABC+0	ABCDE+0	ABCDE+A	ABCDE+AB
21.26	82.0	292,100	292,100	292,100	210,800	234,200	271,200	291,800	280,700	264,900
25	80.3	250,100	250,100	250,100	156,700	198,400	230,000	250,100	250,100	238,000
30	78.1	207,400	207,400	207,400	109,800	152,000	190,600	207,400	207,400	204,400
35	75.8	176,700	176,700	176,700	83,300	116,500	162,000	176,700	176,700	176,700
40	73.5	153,600	153,600	153,600	66,600	93,500	136,300	153,600	153,600	153,600
50	68.9	121,000	121,000	121,000	46,200	66,200	97,500	118,200	121,000	121,000
60	64.1	98,900	98,900	98,900	34,600	50,200	75,200	91,200	93,700	97,000
70	59.1	80,500	83,100	83,100	26,800	39,900	60,300	73,800	75,900	78,600
80	53.8	67,000	71,500	71,500	21,400	32,500	49,900	61,400	63,100	65,500
90	48.1	57,100	62,200	62,200	17,300	27,000	42,100	52,100	53,700	55,700
100	41.9	49,400	54,100	54,800	14,100	22,700	36,300	45,000	46,300	48,200
110	34.7	43,200	47,500	48,600	11,600	19,300	31,500	39,500	40,500	42,200
120	26.0	38,400	42,100	43,000	9,500	16,500	27,600	34,800	35,900	37,400
130	12.7	34,200	37,700	38,300	7,800	14,200	24,300	30,900	31,900	33,300

Main Boom Capacities – On Outriggers – 140 Ft Open Throat Tube Boom

Load Radius (ft)	Boom Angle (deg)	Counterweight Combinations – Upper + Bumper								
		Over The Rear			360 Degree Rotation					
		ABCDE+0	ABCDE+A	ABCDE+AB	0+0	A+0	ABC+0	ABCDE+0	ABCDE+A	ABCDE+AB
22.65	82.0	268,800	268,800	268,800	194,400	218,500	253,300	268,800	268,000	252,900
25	81.0	249,200	249,200	249,200	156,800	197,600	229,200	249,200	249,200	237,000
30	79.0	206,600	206,600	206,600	109,700	151,900	189,900	206,600	206,600	203,600
35	76.9	176,000	176,000	176,000	83,100	116,300	161,600	176,000	176,000	176,000
40	74.7	153,000	153,000	153,000	66,500	93,300	136,000	153,000	153,000	153,000
50	70.5	120,400	120,400	120,400	46,000	66,000	97,300	117,900	120,400	120,400
60	66.0	98,300	98,300	98,300	34,400	49,900	74,900	90,900	93,400	96,700
70	61.5	80,100	82,500	82,500	26,600	39,600	60,000	73,500	75,600	78,300
80	56.7	66,700	70,900	70,900	21,100	32,200	49,500	61,000	62,800	65,100
90	51.7	56,700	61,700	61,700	17,000	26,700	41,800	51,800	53,300	55,400
100	46.2	49,000	53,700	54,300	13,800	22,400	36,000	44,600	46,000	47,800
110	40.3	42,900	47,100	47,800	11,300	19,000	31,200	39,200	40,400	41,800
120	33.4	38,100	41,700	42,400	9,200	16,200	27,300	34,500	35,600	37,100
130	25.0	33,900	37,400	38,300	7,500	13,900	24,000	30,700	31,700	33,000
140	12.2	30,400	33,600	33,800	6,000	11,900	21,300	27,400	28,300	29,500

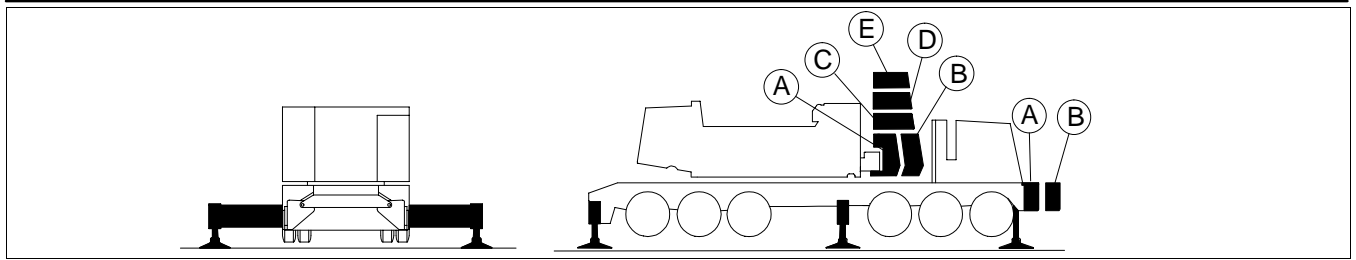

Main Boom Capacities – On Outriggers – 150 Ft Open Throat Tube Boom										
Load Radius (ft)	Boom Angle (deg)	Counterweight Combinations – Upper + Bumper								
		Over The Rear			360 Degree Rotation					
		ABCDE+0	ABCDE+A	ABCDE+AB	0+0	A+0	ABC+0	ABCDE+0	ABCDE+A	ABCDE+AB
24.04	82.0	250,600	250,600	250,600	170,200	204,600	237,700	250,600	250,600	242,300
25	81.6	248,200	248,200	248,200	156,800	196,800	228,300	248,200	248,200	236,000
30	79.7	205,800	205,800	205,800	109,600	151,800	189,100	205,800	205,800	202,800
35	77.7	175,300	175,300	175,300	83,000	116,200	161,000	175,300	175,300	175,300
40	75.8	152,300	152,300	152,300	66,300	93,100	135,800	152,300	152,300	152,300
50	71.8	119,800	119,800	119,800	45,700	65,700	97,000	117,600	119,800	119,800
60	67.7	97,700	97,800	97,700	34,100	49,500	74,600	90,500	93,000	96,400
70	63.5	79,800	82,000	82,000	26,200	39,300	59,700	73,200	75,200	78,000
80	59.2	66,400	70,400	70,400	20,700	31,900	49,200	60,700	62,400	64,800
90	54.6	56,400	61,200	61,100	16,600	26,300	41,400	51,400	52,900	55,000
100	49.8	48,600	53,300	53,500	13,400	22,100	35,700	44,300	45,600	47,400
110	44.6	42,500	46,700	47,100	10,900	18,600	30,900	38,800	40,100	41,400
120	38.8	37,700	41,300	41,700	8,900	15,900	27,000	34,200	35,300	36,800
130	32.3	33,600	37,100	37,800	7,100	13,600	23,700	30,300	31,300	32,700
140	24.2	30,100	33,300	33,700	5,700	11,600	20,900	27,000	28,000	29,200
150	11.8	27,000	29,800	29,800	4,400	9,900	18,600	24,200	25,100	26,200

Main Boom Capacities – On Outriggers – 160 Ft Open Throat Tube Boom										
Load Radius (ft)	Boom Angle (deg)	Counterweight Combinations – Upper + Bumper								
		Over The Rear			360 Degree Rotation					
		ABCDE+0	ABCDE+A	ABCDE+AB	0+0	A+0	ABC+0	ABCDE+0	ABCDE+A	ABCDE+AB
25.43	82.0	230,800	230,800	230,800	151,300	192,500	223,400	230,800	230,800	230,800
30	80.3	205,000	205,000	205,000	109,500	151,700	188,400	205,000	205,000	202,000
35	78.5	174,500	174,500	174,500	82,800	116,000	160,300	174,500	174,500	174,500
40	76.7	151,600	151,600	151,600	66,000	92,900	135,500	151,600	151,600	151,600
50	73.0	119,200	119,200	119,200	45,400	65,400	96,700	117,300	119,200	119,200
60	69.2	97,200	97,200	97,200	33,800	49,200	74,200	90,200	92,700	96,000
70	65.3	79,500	81,400	81,400	25,900	39,000	59,300	72,800	74,900	77,600
80	61.3	66,000	69,900	69,900	20,400	31,500	48,800	60,300	62,100	64,400
90	57.1	56,000	60,500	60,500	16,300	26,000	41,000	51,000	52,600	54,600
100	52.8	48,200	52,600	52,600	13,100	21,700	35,300	43,900	45,200	47,000
110	48.1	42,100	46,300	46,300	10,600	18,300	30,500	38,500	39,700	41,000
120	43.1	37,400	40,900	41,000	8,500	15,500	26,600	33,800	34,900	36,400
130	37.6	33,200	36,700	37,300	6,800	13,200	23,300	30,000	31,000	32,300
140	31.2	29,700	32,900	33,200	5,300	11,200	20,600	26,700	27,600	28,900
150	23.4	26,700	29,700	29,700	4,100	9,600	18,200	23,900	24,800	25,900
160	11.4	24,100	26,400	26,400	3,000	8,100	16,200	21,500	22,300	23,300

Main Boom Capacities – On Outriggers – 170 Ft Open Throat Tube Boom										
Load Radius (ft)	Boom Angle (deg)	Counterweight Combinations – Upper + Bumper								
		Over The Rear			360 Degree Rotation					
		ABCDE+0	ABCDE+A	ABCDE+AB	0+0	A+0	ABC+0	ABCDE+0	ABCDE+A	ABCDE+AB
26.83	82.0	212,000	212,000	212,000	135,600	181,200	210,500	212,000	212,000	212,000
30	80.9	204,100	204,100	204,100	109,400	151,600	187,600	204,100	204,100	201,500
35	79.2	173,800	173,800	173,800	82,600	115,800	159,600	173,800	173,800	173,800
40	77.5	151,000	151,000	151,000	65,800	92,600	135,200	151,000	151,000	150,900
50	74.0	118,600	118,600	118,600	45,100	65,100	96,300	117,000	118,600	118,600
60	70.5	96,600	96,600	96,600	33,500	48,900	73,900	89,800	92,300	95,700
70	66.9	79,100	80,800	80,800	25,600	38,700	59,000	72,500	74,500	77,300
80	63.1	65,600	69,300	69,300	20,000	31,200	48,400	59,900	61,700	64,100
90	59.3	55,600	59,600	59,600	15,900	25,600	40,600	50,700	52,200	54,200
100	55.3	47,800	51,800	51,800	12,700	21,300	34,900	43,500	44,800	46,600
110	51.1	41,700	45,500	45,500	10,200	17,900	30,100	38,100	39,300	40,600
120	46.6	37,000	40,200	40,200	8,100	15,100	26,200	33,400	34,500	36,000
130	41.7	32,800	36,300	36,600	6,400	12,800	23,000	29,600	30,600	31,900
140	36.4	29,300	32,500	32,700	4,900	10,900	20,200	26,300	27,200	28,500
150	30.3	26,300	29,200	29,200	3,700	9,200	17,900	23,500	24,400	25,500
160	22.7	23,700	26,200	26,200	2,600	7,700	15,800	21,100	21,900	23,000
170	11.1	21,400	23,300	23,300	-	6,500	14,000	19,000	19,700	20,700

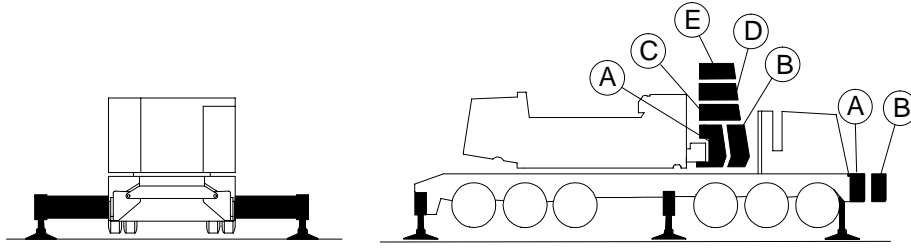

Main Boom Capacities – On Outriggers – 180 Ft Open Throat Tube Boom

Load Radius (ft)	Boom Angle (deg)	Counterweight Combinations – Upper + Bumper								
		Over The Rear			360 Degree Rotation					
		ABCDE+0	ABCDE+A	ABCDE+AB	0+0	A+0	ABC+0	ABCDE+0	ABCDE+A	ABCDE+AB
28.22	82.0	188,800	188,800	188,800	122,500	169,400	188,800	188,800	188,800	188,800
30	81.4	188,800	188,800	188,800	109,300	151,400	186,800	188,800	188,800	188,800
35	79.8	173,000	173,000	173,000	82,400	115,600	158,800	173,000	173,000	173,000
40	78.2	150,300	150,300	150,300	65,600	92,400	134,900	150,300	150,300	150,300
50	74.9	117,900	117,900	117,900	44,800	64,800	96,000	116,700	117,900	117,900
60	71.6	95,900	95,900	95,900	33,100	48,500	73,500	89,500	92,000	95,300
70	68.2	78,700	80,600	80,600	25,200	38,300	58,600	72,100	74,200	76,900
80	64.7	65,200	68,500	68,500	19,700	30,800	48,100	59,600	61,300	63,700
90	61.2	55,200	58,700	58,700	15,500	25,300	40,200	50,300	51,800	53,800
100	57.5	47,400	51,000	51,000	12,300	20,900	34,600	43,100	44,400	46,200
110	53.6	41,300	44,700	44,700	9,800	17,500	29,700	37,700	38,900	40,200
120	49.5	36,600	40,400	40,500	7,700	14,700	25,800	33,100	34,200	35,600
130	45.2	32,400	35,900	35,900	6,000	12,400	22,600	29,200	30,200	31,500
140	40.5	28,900	32,100	32,100	4,600	10,500	19,800	25,900	26,800	28,100
150	35.3	25,900	28,700	28,700	3,300	8,800	17,500	23,100	24,000	25,100
160	29.4	23,300	25,700	25,700	2,200	7,300	15,400	20,700	21,500	22,600
170	22.1	21,000	23,000	23,000	-	6,100	13,700	18,600	19,300	20,400
180	10.8	19,000	20,500	20,500	-	5,000	12,100	16,700	17,400	18,400

Main Boom Capacities – On Outriggers – 190 Ft Open Throat Tube Boom

Load Radius (ft)	Boom Angle (deg)	Counterweight Combinations – Upper + Bumper								
		Over The Rear			360 Degree Rotation					
		ABCDE+0	ABCDE+A	ABCDE+AB	0+0	A+0	ABC+0	ABCDE+0	ABCDE+A	ABCDE+AB
29.61	82.0	168,700	168,700	168,700	111,900	155,000	168,700	168,700	168,700	168,700
30	81.9	168,700	168,700	168,700	109,200	151,300	168,700	168,700	168,700	168,700
35	80.4	168,700	168,700	168,700	82,100	115,300	158,100	168,700	168,700	168,700
40	78.8	149,500	149,500	149,500	65,300	92,100	134,700	149,600	149,600	149,600
50	75.7	117,300	117,300	117,300	44,500	64,500	95,700	116,300	117,300	117,300
60	72.6	95,300	95,300	95,300	32,800	48,200	73,200	89,100	91,600	94,900
70	69.4	78,400	80,000	80,000	24,900	38,000	58,200	71,700	73,800	76,500
80	66.1	64,800	67,600	67,600	19,300	30,500	47,700	59,200	60,900	63,300
90	62.8	54,800	57,800	57,800	15,200	24,900	40,200	49,800	51,400	53,400
100	59.4	47,000	50,100	50,100	12,000	20,600	34,200	42,700	44,000	45,800
110	55.8	40,900	43,900	43,900	9,400	17,100	29,300	37,300	38,500	40,200
120	52.1	36,200	39,800	39,800	7,300	14,300	25,400	32,700	33,800	35,200
130	48.1	32,000	35,300	35,300	5,600	12,000	22,200	28,800	29,800	31,100
140	43.9	28,500	31,400	31,400	4,100	10,100	19,400	25,500	26,400	27,700
150	39.4	25,500	28,100	28,100	2,900	8,400	17,100	22,700	23,600	24,700
160	34.4	22,900	25,200	25,200	-	6,900	15,000	20,300	21,100	22,200
170	28.6	20,600	22,600	22,600	-	5,700	13,200	18,200	18,900	20,000
180	21.5	18,600	20,200	20,200	-	4,600	11,700	16,300	17,000	18,000
190	10.5	16,800	17,900	17,900	-	3,600	10,300	14,700	15,300	16,200

Main Boom Capacities – On Outriggers – 200 Ft Open Throat Tube Boom

Load Radius (ft)	Boom Angle (deg)	Counterweight Combinations – Upper + Bumper								
		Over The Rear			360 Degree Rotation					
		ABCDE+0	ABCDE+A	ABCDE+AB	0+0	A+0	ABC+0	ABCDE+0	ABCDE+A	ABCDE+AB
31	82.0	149,200	149,200	149,200	PROHIBITED	142,200	149,200	149,200	149,200	149,200
35	80.8	149,200	149,200	149,200		115,100	149,200	149,200	149,200	149,200
40	79.4	148,800	148,800	148,800		91,800	134,400	148,800	148,800	148,800
50	76.5	116,700	116,700	116,600		64,200	95,300	116,000	116,700	116,600
60	73.5	94,700	94,700	94,700		47,800	72,800	88,700	91,200	94,500
70	70.5	78,000	79,400	79,400		37,600	57,800	71,300	73,400	76,200
80	67.4	64,400	66,700	66,700		30,100	47,300	58,800	60,500	62,900
90	64.3	54,400	57,000	57,000		24,500	39,800	49,400	51,000	53,000
100	61.0	46,600	49,300	49,300		20,200	33,800	42,200	43,600	45,400
110	57.7	40,400	43,100	43,100		16,700	28,900	36,900	38,100	39,800
120	54.3	35,800	39,100	39,100		13,900	25,000	32,200	33,300	34,800
130	50.6	31,600	34,600	34,600		11,600	21,700	28,400	29,400	30,700
140	46.8	28,100	30,800	30,800		9,600	19,000	25,100	26,000	27,300
150	42.8	25,100	27,500	27,500		8,000	16,600	22,300	23,200	24,300
160	38.4	22,500	24,600	24,600		6,500	14,600	19,900	20,700	21,800
170	33.5	20,200	22,000	22,000		5,300	12,800	17,800	18,500	19,500
180	27.9	18,200	19,700	19,700		4,100	11,300	15,900	16,600	17,600
190	20.9	16,400	17,600	17,600		3,200	9,900	14,300	14,900	15,800
200	10.2	14,800	15,600	15,600		2,300	8,600	12,800	13,400	14,300

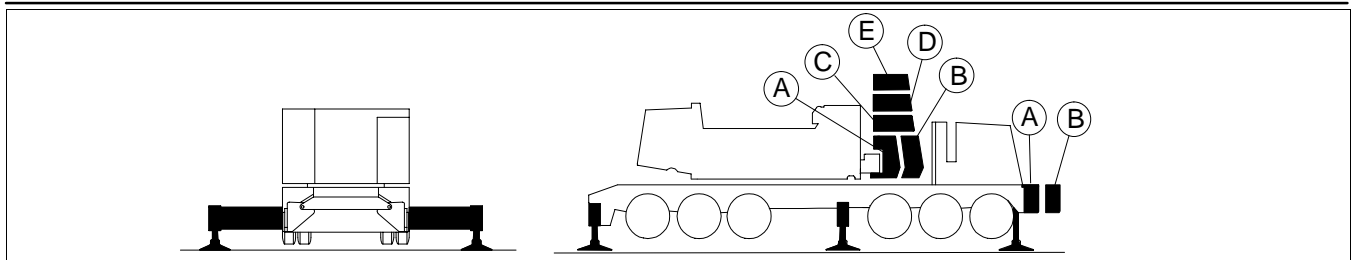

Main Boom Capacities – On Outriggers – 210 Ft Open Throat Tube Boom										
Load Radius (ft)	Boom Angle (deg)	Counterweight Combinations – Upper + Bumper								
		Over The Rear			360 Degree Rotation					
		ABCDE+0	ABCDE+A	ABCDE+AB	0+0	A+0	ABC+0	ABCDE+0	ABCDE+A	ABCDE+AB
32.39	82.0	135,000	135,000	135,000	PROHIBITED	131,200	135,000	135,000	135,000	135,000
35	81.3	135,000	135,000	135,000		114,900	135,000	135,000	135,000	135,000
40	79.9	135,000	135,000	135,000		91,500	134,000	135,000	135,000	135,000
50	77.1	116,000	116,000	116,000		63,800	95,000	115,600	116,000	116,000
60	74.3	94,000	94,000	94,000		47,500	72,500	88,300	90,800	94,000
70	71.4	77,600	78,500	78,500		37,300	57,400	70,900	73,000	75,800
80	68.5	64,000	65,800	65,800		29,700	46,900	58,400	60,100	62,500
90	65.6	54,000	56,200	56,200		24,100	39,500	49,000	50,500	52,600
100	62.5	46,200	48,500	48,500		19,800	33,400	41,800	43,200	45,000
110	59.4	40,000	42,400	42,400		16,300	28,500	36,500	37,700	39,400
120	56.2	35,400	38,400	38,300		13,500	24,600	31,800	32,900	34,400
130	52.8	31,200	33,900	33,900		11,200	21,300	28,000	29,000	30,300
140	49.3	27,700	30,100	30,100		9,200	18,600	24,700	25,600	26,900
150	45.6	24,700	26,800	26,800		7,500	16,200	21,900	22,700	23,900
160	41.7	22,100	24,000	24,000		6,100	14,200	19,500	20,300	21,300
170	37.4	19,800	21,400	21,400		4,800	12,400	17,300	18,100	19,100
180	32.6	17,800	19,200	19,200		3,700	10,800	15,500	16,200	17,100
190	27.2	16,000	17,200	17,200		2,700	9,500	13,800	14,500	15,400
200	20.4	14,400	15,300	15,300		-	8,200	12,400	13,000	13,800
210	10.0	13,000	13,500	13,500		-	7,100	11,000	11,600	12,500

Main Boom Capacities – On Outriggers – 220 Ft Open Throat Tube Boom										
Load Radius (ft)	Boom Angle (deg)	Counterweight Combinations – Upper + Bumper								
		Over The Rear			360 Degree Rotation					
		ABCDE+0	ABCDE+A	ABCDE+AB	0+0	A+0	ABC+0	ABCDE+0	ABCDE+A	ABCDE+AB
33.79	82.0	123,800	123,800	123,800	PROHIBITED	121,500	123,800	123,800	123,800	123,800
35	81.7	120,700	120,700	120,700		114,700	120,700	120,700	120,700	120,700
40	80.4	119,200	119,200	119,200		91,200	119,200	119,200	119,200	119,200
50	77.7	115,300	115,300	115,300		63,500	94,600	115,300	115,300	115,300
60	75.0	93,000	93,000	93,100		47,100	72,100	87,900	90,400	93,000
70	72.3	77,200	77,600	77,600		36,900	57,100	70,600	72,600	75,400
80	69.6	63,600	65,000	65,000		29,300	46,400	58,000	59,700	62,100
90	66.8	53,500	55,400	55,400		23,700	39,100	48,600	50,100	52,200
100	63.9	45,700	47,800	47,800		19,400	33,000	41,400	42,700	44,500
110	60.9	40,000	41,600	41,600		15,900	28,100	36,100	37,300	38,900
120	57.9	35,000	37,600	37,600		13,100	24,200	31,400	32,500	34,000
130	54.8	30,800	33,200	33,200		10,800	20,900	27,500	28,500	29,900
140	51.5	27,300	29,400	29,400		8,800	18,100	24,200	25,200	26,400
150	48.1	24,200	26,200	26,200		7,100	15,800	21,400	22,300	23,500
160	44.5	21,600	23,300	23,300		5,700	13,700	19,000	19,800	20,900
170	40.7	19,300	20,800	20,800		4,400	12,000	16,900	17,700	18,900
180	36.5	17,300	18,600	18,600		3,300	10,400	15,100	15,800	16,700
190	31.9	15,600	16,600	16,600		2,300	9,000	13,400	14,100	15,000
200	26.5	14,000	14,800	14,800		-	7,800	11,900	12,600	13,400
210	19.9	12,600	13,100	13,100		-	6,700	10,600	11,200	12,000
220	9.7	11,300	11,500	11,500		-	5,700	9,400	10,000	10,800

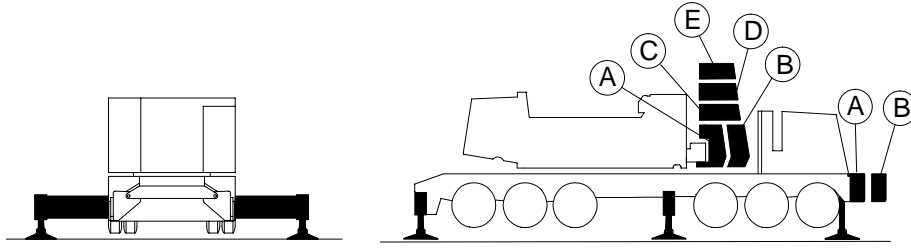

Main Boom Capacities – On Outriggers – 230 Ft Open Throat Tube Boom

Load Radius (ft)	Boom Angle (deg)	Counterweight Combinations – Upper + Bumper									
		Over The Rear			360 Degree Rotation						
		ABCDE+0	ABCDE+A	ABCDE+AB	0+0	A+0	ABC+0	ABCDE+0	ABCDE+A	ABCDE+AB	
35.18	82.0	107,800	107,800	107,800	PROHIBITED		107,800	107,800	107,800	107,800	
40	80.8	106,500	106,500	106,500			106,500	106,500	106,500	106,500	
50	78.3	106,500	106,500	106,500				94,400	106,500	106,500	106,500
60	75.7	92,300	92,300	92,300				71,900	87,700	90,100	92,300
70	73.1	76,900	76,900	76,900				56,800	70,300	72,300	75,100
80	70.5	63,300	64,300	64,300				46,200	57,700	59,400	61,800
90	67.8	53,200	54,700	54,700				38,800	48,300	49,800	51,900
100	65.1	45,400	47,200	47,200				32,700	41,100	42,400	44,200
110	62.3	39,700	41,000	41,000				27,800	35,800	37,000	38,700
120	59.5	34,700	37,100	37,100				23,900	31,100	32,200	33,700
130	56.5	30,500	32,700	32,700				20,600	27,200	28,200	29,600
140	53.5	27,000	28,900	28,900				17,800	23,900	24,900	26,100
150	50.3	23,900	25,700	25,700				15,500	21,100	22,000	23,200
160	47.0	21,300	22,900	22,900				13,400	18,700	19,500	20,600
170	43.5	19,000	20,400	20,400				11,700	16,600	17,400	18,400
180	39.8	17,000	18,200	18,200				10,100	14,700	15,400	16,400
190	35.7	15,200	16,200	16,200				8,700	13,100	13,800	14,700
200	31.2	13,700	14,400	14,400				7,500	11,600	12,300	13,100
210	25.9	12,200	12,800	12,800				6,400	10,300	10,900	11,700
220	19.5	11,000	11,300	11,300				5,400	9,100	9,700	10,400
230	9.5	9,800	9,800	9,800				4,500	8,000	8,600	9,300

Main Boom Capacities – On Outriggers – 240 Ft Open Throat Tube Boom

Load Radius (ft)	Boom Angle (deg)	Counterweight Combinations – Upper + Bumper									
		Over The Rear			360 Degree Rotation						
		ABCDE+0	ABCDE+A	ABCDE+AB	0+0	A+0	ABC+0	ABCDE+0	ABCDE+A	ABCDE+AB	
36.57	82.0	98,500	98,500	98,500	PROHIBITED		98,500	98,500	98,500	98,500	
40	81.2	97,200	97,200	97,200				97,200	97,200	97,200	97,200
50	78.7	96,000	96,000	96,000				94,200	96,000	96,000	96,000
60	76.3	91,600	91,600	91,600				71,600	87,400	89,900	91,600
70	73.8	76,200	76,200	76,200				56,500	70,000	72,100	74,800
80	71.3	63,000	63,700	63,700				45,900	57,400	59,100	61,500
90	68.8	52,900	54,100	54,100				38,500	48,000	49,500	51,600
100	66.2	45,100	46,600	46,600				32,400	40,800	42,100	43,900
110	63.6	39,400	40,400	40,400				27,500	35,500	36,700	38,400
120	60.9	34,400	36,500	36,500				23,600	30,800	31,900	33,400
130	58.1	30,200	32,100	32,100				20,300	26,900	27,900	29,300
140	55.2	26,600	28,400	28,400				17,500	23,600	24,600	25,800
150	52.3	23,600	25,200	25,200				15,200	20,800	21,700	22,900
160	49.2	21,000	22,400	22,400				13,100	18,400	19,200	20,300
170	46.0	18,700	19,900	19,900				11,300	16,300	17,000	18,100
180	42.5	16,700	17,700	17,700				9,800	14,400	15,100	16,100
190	38.9	14,900	15,800	15,800				8,400	12,800	13,400	14,300
200	34.9	13,300	14,000	14,000				7,100	11,300	11,900	12,800
210	30.5	11,900	12,400	12,400				6,000	10,000	10,600	11,400
220	25.4	10,600	10,900	10,900				5,000	8,800	9,400	10,100
230	19.1	9,500	9,500	9,500				4,100	7,700	8,300	9,000
240	9.3	8,200	8,200	8,200				3,300	6,700	7,300	8,000

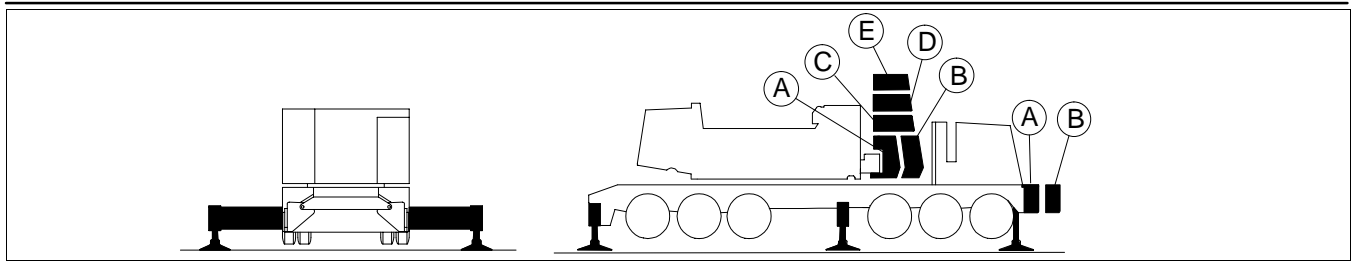

Main Boom Capacities – On Outriggers – 250 Ft Open Throat Tube Boom										
Load Radius (ft)	Boom Angle (deg)	Counterweight Combinations – Upper + Bumper								
		Over The Rear			360 Degree Rotation					
		ABCDE+0	ABCDE+A	ABCDE+AB	0+0	A+0	ABC+0	ABCDE+0	ABCDE+A	ABCDE+AB
37.96	82.0	89,300	89,300	89,300	PROHIBITED		89,300	89,300	89,300	89,300
40	81.5	89,300	89,300	89,300		89,300	89,300	89,300	89,300	89,300
50	79.2	88,200	88,200	88,200		88,200	88,200	88,200	88,200	88,200
60	76.9	87,100	87,100	87,100		88,200	87,100	87,100	87,100	87,100
70	74.5	75,500	75,500	75,500		71,400	75,500	87,100	71,800	74,600
80	72.1	62,700	63,000	63,000		45,600	69,700	57,100	58,800	61,200
90	69.7	52,600	53,400	53,400		38,200	47,700	49,200	49,200	51,200
100	67.2	44,800	45,900	45,900		32,100	40,400	41,800	41,800	43,600
110	64.7	39,100	39,800	39,800		27,200	35,200	36,400	36,400	38,000
120	62.1	34,000	35,900	35,900		23,200	30,500	31,600	31,600	33,000
130	59.5	29,800	31,500	31,500		19,900	26,600	27,600	27,600	28,900
140	56.8	26,300	27,800	27,800		17,200	23,300	24,200	24,200	25,400
150	54.0	23,200	24,400	24,400		14,800	20,400	21,300	21,300	22,500
160	51.1	20,600	21,800	21,800		12,700	18,000	18,800	18,800	19,900
170	48.1	18,300	19,300	19,300		10,900	15,900	16,600	16,600	17,600
180	45.0	16,300	17,100	17,100		9,400	14,000	14,700	14,700	15,700
190	41.6	14,500	15,200	15,200		8,000	12,400	13,000	13,000	13,900
200	38.1	12,900	13,400	13,400		6,700	10,900	11,500	11,500	12,400
210	34.2	11,500	11,800	11,800		5,600	9,500	10,100	10,100	11,000
220	29.8	10,200	10,400	10,400		4,600	8,400	8,900	8,900	9,700
230	24.9	9,000	9,000	9,000		3,700	7,300	7,800	7,800	8,500
240	18.7	7,800	7,800	7,800		2,900	6,300	6,800	6,800	7,500
250	9.1	6,500	6,500	6,500		2,100	5,400	5,900	5,900	6,500

Main Boom Capacities – On Outriggers – 260 Ft Open Throat Tube Boom										
Load Radius (ft)	Boom Angle (deg)	Counterweight Combinations – Upper + Bumper								
		Over The Rear			360 Degree Rotation					
		ABCDE+0	ABCDE+A	ABCDE+AB	0+0	A+0	ABC+0	ABCDE+0	ABCDE+A	ABCDE+AB
39.35	82.0	81,600	81,600	81,600	PROHIBITED		81,600	81,600	81,600	81,600
40	81.9	81,600	81,600	81,600		81,600	81,600	81,600	81,600	81,600
50	79.6	77,600	77,600	77,600		77,600	77,600	77,600	77,600	77,600
60	77.4	76,600	76,600	76,600		71,100	76,600	76,600	76,600	76,600
70	75.1	70,800	70,800	70,800		56,000	69,500	70,800	70,800	70,800
80	72.8	62,400	62,400	62,400		45,300	56,800	58,500	58,500	60,900
90	70.5	52,300	52,800	52,800		37,900	47,300	48,900	48,900	50,900
100	68.1	44,400	45,300	45,300		31,800	40,100	41,400	41,400	43,200
110	65.7	38,800	40,200	40,200		26,900	34,900	36,100	36,100	37,700
120	63.3	33,700	35,400	35,400		22,900	30,200	31,300	31,300	32,700
130	60.8	29,500	31,000	31,000		19,600	26,200	27,200	27,200	28,600
140	58.2	25,900	27,300	27,300		16,800	22,900	23,900	23,900	25,100
150	55.6	22,900	24,100	24,100		14,500	20,100	21,000	21,000	22,100
160	52.9	20,300	21,300	21,300		12,400	17,700	18,500	18,500	19,600
170	50.1	18,000	18,800	18,800		10,600	15,600	16,300	16,300	17,300
180	47.1	16,000	16,600	16,600		9,000	13,700	14,400	14,400	15,300
190	44.1	14,200	14,700	14,700		7,600	12,000	12,700	12,700	13,600
200	40.8	12,600	13,000	13,000		6,400	10,500	11,200	11,200	12,000
210	37.3	11,200	11,400	11,400		5,300	9,200	9,800	9,800	10,600
220	33.5	9,900	9,900	10,000		4,300	8,000	8,600	8,600	9,400
230	29.3	8,600	8,600	8,600		3,400	6,900	7,500	7,500	8,200
240	24.4	7,400	7,400	7,400		2,500	5,900	6,500	6,500	7,200
250	18.3	6,300	6,300	6,300		-	5,000	5,500	5,500	6,200
260	9.0	5,100	5,100	5,100		-	4,200	4,700	4,700	5,100

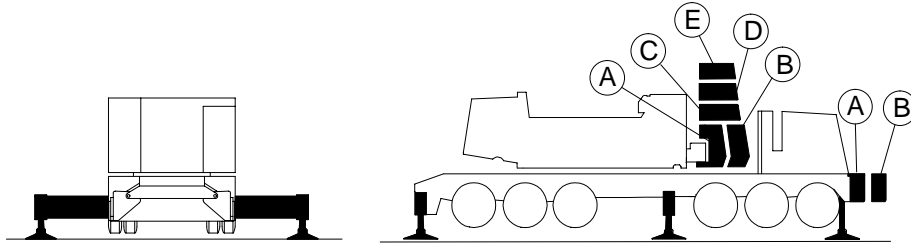

Main Boom Capacities – On Outriggers – 270 Ft Open Throat Tube Boom

Load Radius (ft)	Boom Angle (deg)	Counterweight Combinations – Upper + Bumper								
		Over The Rear			360 Degree Rotation					
		ABCDE+0	ABCDE+A	ABCDE+AB	0+0	A+0	ABC+0	ABCDE+0	ABCDE+A	ABCDE+AB
40.74	82.0	71,700	71,700	71,700	PROHIBITED		71,700	71,700	71,700	71,700
50	80.0	70,800	70,800	70,800			70,800	70,800	70,800	70,800
60	77.8	69,900	69,900	69,900			69,900	69,900	69,900	69,900
70	75.7	64,600	64,600	64,600			55,700	64,600	64,600	64,600
80	73.5	59,800	59,800	59,800			45,000	56,500	58,200	59,800
90	71.2	52,000	52,200	52,200			37,600	47,000	48,600	50,600
100	69.0	44,100	44,700	44,700			31,500	39,800	41,100	42,900
110	66.7	38,500	40,000	40,000			26,600	34,600	35,800	37,400
120	64.4	33,400	34,800	34,800			22,600	29,800	30,900	32,400
130	62.0	29,200	30,500	30,400			19,300	25,900	26,900	28,300
140	59.5	25,600	26,700	26,700			16,500	22,600	23,500	24,800
150	57.1	22,600	23,500	23,600			14,100	19,800	20,700	21,800
160	54.5	20,000	20,800	20,800			12,100	17,400	18,200	19,200
170	51.8	17,700	18,300	18,300			10,300	15,200	16,000	17,000
180	49.1	15,600	16,200	16,200			8,700	13,400	14,100	15,000
190	46.2	13,800	14,200	14,200			7,300	11,700	12,400	13,300
200	43.2	12,300	12,500	12,500			6,100	10,200	10,800	11,700
210	40.0	10,800	10,900	10,900			4,900	8,900	9,500	10,300
220	36.6	9,500	9,500	9,500			3,900	7,700	8,200	9,000
230	32.8	8,200	8,200	8,200			3,000	6,600	7,100	7,900
240	28.7	7,000	7,000	7,000			2,200	5,600	6,100	6,800
250	23.9	5,900	5,900	5,900			-	4,700	5,200	5,900
260	18.0	4,800	4,800	4,800			-	3,900	4,400	4,800
270	8.8	3,800	3,800	3,800			-	3,100	3,600	3,800

Main Boom Capacities – On Outriggers – 280 Ft Open Throat Tube Boom

Load Radius (ft)	Boom Angle (deg)	Counterweight Combinations – Upper + Bumper								
		Over The Rear			360 Degree Rotation					
		ABCDE+0	ABCDE+A	ABCDE+AB	0+0	A+0	ABC+0	ABCDE+0	ABCDE+A	ABCDE+AB
42.14	82.0	65,600	65,600	65,600	PROHIBITED		65,600	65,600	65,600	65,600
50	80.4	64,800	64,800	64,800			64,800	64,800	64,800	64,800
60	78.3	64,000	64,000	64,000			64,000	64,000	64,000	64,000
70	76.2	59,200	59,200	59,200			59,200	59,200	59,200	59,200
80	74.1	54,800	54,800	54,800			54,800	54,800	54,800	54,800
90	71.9	50,000	50,000	50,000			46,700	48,200	50,000	50,000
100	69.8	43,800	44,100	44,100			40,100	40,800	42,600	42,600
110	67.6	38,200	39,500	39,500			34,200	35,500	37,100	37,100
120	65.3	33,100	34,300	34,300			29,500	30,600	32,100	32,100
130	63.1	28,900	29,900	29,900			25,600	26,600	28,000	28,000
140	60.7	25,300	26,200	26,200			22,300	23,200	24,500	24,500
150	58.4	22,200	23,000	23,000			19,500	20,300	21,500	21,500
160	55.9	19,600	20,300	20,300			17,000	17,800	18,900	18,900
170	53.4	17,300	17,800	17,800			14,900	15,600	16,700	16,700
180	50.8	15,300	15,700	15,700			13,000	13,700	14,700	14,700
190	48.1	13,500	13,800	13,800			11,300	12,000	12,900	12,900
200	45.3	11,900	12,000	12,000			9,900	10,500	11,300	11,300
210	42.4	10,500	10,500	10,500			8,500	9,100	9,900	9,900
220	39.2	9,100	9,000	9,100			7,300	7,900	8,700	8,700
230	35.9	7,800	7,800	7,800			6,200	6,800	7,500	7,500
240	32.2	6,600	6,600	6,600			5,300	5,800	6,500	6,500
250	28.2	5,500	5,500	5,500			4,300	4,800	5,500	5,500
260	23.5	4,400	4,400	4,400			3,500	4,000	4,400	4,400
270	17.6	3,500	3,500	3,500			2,800	3,200	3,500	3,500
280	8.6	2,500	2,500	2,500			2,100	2,500	2,500	2,500

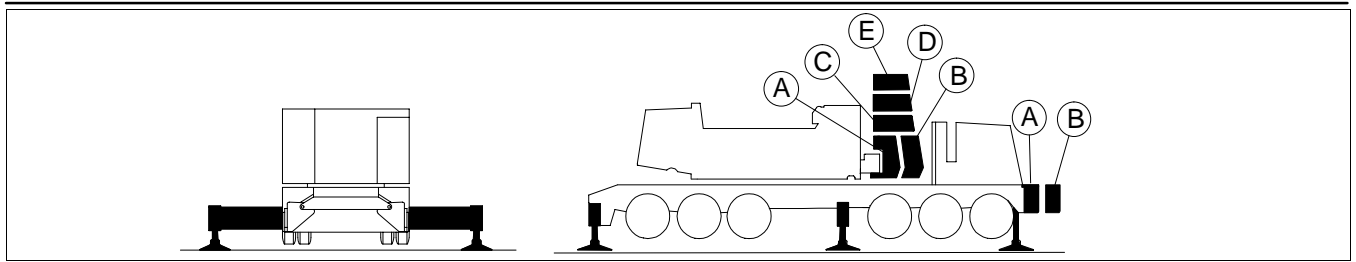

Main Boom Capacities – On Outriggers – 290 Ft Open Throat Tube Boom										
Load Radius (ft)	Boom Angle (deg)	Counterweight Combinations – Upper + Bumper								
		Over The Rear			360 Degree Rotation					
		ABCDE+0	ABCDE+A	ABCDE+AB	0+0	A+0	ABC+0	ABCDE+0	ABCDE+A	ABCDE+AB
43.53	82.0	61,000	61,000	61,000	PROHIBITED	PROHIBITED	PROHIBITED	61,000	61,000	61,000
50	80.7	60,200	60,200	60,200				60,200	60,200	60,200
60	78.7	59,500	59,500	59,500				59,500	59,500	59,500
70	76.7	55,000	55,000	55,000				55,000	55,000	55,000
80	74.6	50,200	50,200	50,200				50,200	50,200	50,200
90	72.6	46,400	46,400	46,400				46,400	46,400	46,400
100	70.5	42,400	42,400	42,400				39,700	40,400	42,300
110	68.4	36,500	36,500	36,500				33,900	35,100	36,500
120	66.2	32,800	33,700	33,700				29,200	30,300	31,800
130	64.1	28,500	29,400	29,400				25,300	26,300	27,600
140	61.8	25,000	25,700	25,700				22,000	22,900	24,100
150	59.6	21,900	22,500	22,500				19,100	20,000	21,100
160	57.3	19,300	19,800	19,800				16,700	17,500	18,600
170	54.9	17,000	17,300	17,300				14,500	15,300	16,300
180	52.4	15,000	15,200	15,200				12,700	13,400	14,300
190	49.9	13,200	13,300	13,300				11,000	11,700	12,600
200	47.3	11,500	11,500	11,600				9,500	10,100	11,000
210	44.5	10,000	10,000	10,000				8,200	8,800	9,600
220	41.6	8,600	8,600	8,600				7,000	7,600	8,300
230	38.5	7,300	7,300	7,300				5,900	6,400	7,200
240	35.2	6,100	6,100	6,100				4,900	5,400	6,100
250	31.7	5,000	5,000	5,000				4,000	4,500	5,000
260	27.7	4,000	4,000	4,000				3,200	3,600	4,000
270	23.1	3,100	3,100	3,100				2,400	2,900	3,100
280	17.3	2,200	2,200	2,200				-	2,200	2,200

Main Boom Capacities – On Outriggers – 300 Ft Open Throat Tube Boom										
Load Radius (ft)	Boom Angle (deg)	Counterweight Combinations – Upper + Bumper								
		Over The Rear			360 Degree Rotation					
		ABCDE+0	ABCDE+A	ABCDE+AB	0+0	A+0	ABC+0	ABCDE+0	ABCDE+A	ABCDE+AB
44.92	82.0	55,900	55,900	55,900	PROHIBITED	PROHIBITED	PROHIBITED	55,900	55,900	55,900
50	81.0	55,500	55,500	55,500				55,500	55,500	55,500
60	79.1	54,800	54,800	54,800				54,800	54,800	54,800
70	77.1	50,400	50,400	50,400				50,400	50,400	50,400
80	75.2	46,300	46,300	46,300				46,300	46,300	46,300
90	73.2	42,500	42,500	42,500				42,500	42,500	42,500
100	71.2	36,100	36,100	36,100				36,100	36,100	36,100
110	69.1	33,400	33,400	33,400				33,400	33,400	33,400
120	67.1	30,900	30,900	30,900				28,900	30,000	30,900
130	65.0	28,200	28,400	28,400				24,900	25,900	27,300
140	62.9	24,600	25,200	25,200				21,600	22,500	23,800
150	60.7	21,600	22,000	22,000				18,800	19,600	20,800
160	58.5	18,900	19,200	19,200				16,300	17,100	18,200
170	56.2	16,600	16,800	16,800				14,200	15,000	16,000
180	53.9	14,600	14,700	14,700				12,300	13,000	14,000
190	51.5	12,800	12,800	12,800				10,700	11,300	12,200
200	49.0	11,100	11,100	11,100				9,200	9,800	10,600
210	46.4	9,500	9,500	9,500				7,800	8,400	9,200
220	43.7	8,100	8,100	8,100				6,600	7,200	8,000
230	40.9	6,800	6,800	6,800				5,500	6,100	6,800
240	37.9	5,700	5,700	5,700				4,500	5,100	5,700
250	34.6	4,600	4,600	4,600				3,600	4,100	4,600
260	31.1	3,600	3,600	3,600				2,800	3,300	3,600
270	27.2	2,700	2,700	2,700				2,000	2,500	2,700

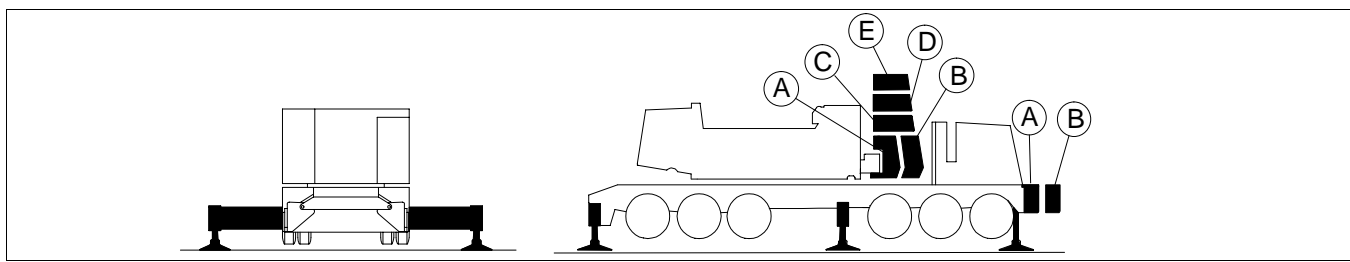

Main Boom Capacities – On Outriggers – 310 Ft Open Throat Tube Boom

Load Radius (ft)	Boom Angle (deg)	Counterweight Combinations – Upper + Bumper									
		Over The Rear			360 Degree Rotation						
		ABCDE+0	ABCDE+A	ABCDE+AB	0+0	A+0	ABC+0	ABCDE+0	ABCDE+A	ABCDE+AB	
46.31	82.0	PROHIBITED	51,500	51,500	PROHIBITED					51,500	51,500
50	81.3		51,200	51,200		51,200	51,200				
60	79.4		50,600	50,600		50,600	50,600				
70	77.5		46,400	46,400		46,400	46,400				
80	75.6		42,700	42,700		42,700	42,700				
90	73.7		36,300	36,300		36,300	36,300				
100	71.8		33,300	33,300		33,300	33,300				
110	69.8		30,800	30,800		30,800	30,800				
120	67.9		28,300	28,300		28,300	28,300				
130	65.8		26,200	26,200		26,200	26,200				
140	63.8		23,900	23,900		23,900	23,900				
150	61.7		21,500	21,500		21,500	21,500				
160	59.6		18,700	18,700		18,700	18,700				
170	57.4		16,300	16,300		16,300	16,300				
180	55.2		14,200	14,200		14,200	14,200				
190	52.9		12,300	12,300		12,300	12,300				
200	50.6		10,600	10,600		10,600	10,600				
210	48.1		9,000	9,000		9,000	9,000				
220	45.6		7,600	7,600		7,600	7,600				
230	43.0		6,400	6,400		6,400	6,400				
240	40.2		5,200	5,200		5,200	5,200				
250	37.2		4,100	4,100		4,100	4,100				
260	34.1		3,100	3,100		3,100	3,100				
270	30.6		2,200	2,200		2,200	2,200				

Main Boom Capacities – On Outriggers – 320 Ft Open Throat Tube Boom

Load Radius (ft)	Boom Angle (deg)	Counterweight Combinations – Upper + Bumper									
		Over The Rear			360 Degree Rotation						
		ABCDE+0	ABCDE+A	ABCDE+AB	0+0	A+0	ABC+0	ABCDE+0	ABCDE+A	ABCDE+AB	
47.7	82.0	PROHIBITED	47,300	47,300	PROHIBITED					47,300	47,300
50	81.6		47,300	47,300		47,300	47,300				
60	79.8		46,400	46,400		46,400	46,400				
70	77.9		42,900	42,900		42,900	42,900				
80	76.1		36,200	36,200		36,200	36,200				
90	74.3		33,500	33,500		33,500	33,500				
100	72.4		30,500	30,500		30,500	30,500				
110	70.5		28,200	28,200		28,200	28,200				
120	68.6		25,900	25,900		25,900	25,900				
130	66.6		24,000	24,000		24,000	24,000				
140	64.7		21,900	21,900		21,900	21,900				
150	62.7		20,200	20,200		20,200	20,200				
160	60.7		18,200	18,200		18,200	18,200				
170	58.6		15,800	15,800		15,800	15,800				
180	56.5		13,700	13,700		13,700	13,700				
190	54.3		11,800	11,800		11,800	11,800				
200	52.0		10,100	10,100		10,100	10,100				
210	49.7		8,500	8,500		8,500	8,500				
220	47.3		7,100	7,100		7,100	7,100				
230	44.9		5,900	5,900		5,900	5,900				
240	42.3		4,700	4,700		4,700	4,700				
250	39.5		3,600	3,600		3,600	3,600				
260	36.6		2,700	2,700		2,700	2,700				

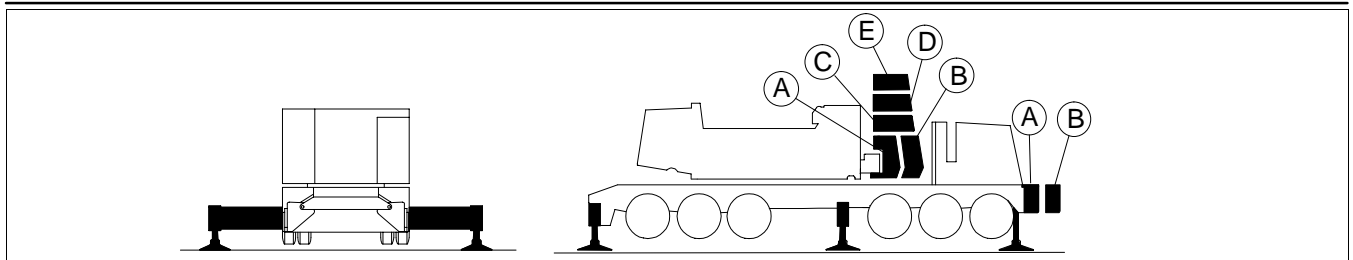

Main Boom Capacities – On Outriggers – 330 Ft Open Throat Tube Boom

Load Radius (ft)	Boom Angle (deg)	Counterweight Combinations – Upper + Bumper								
		Over The Rear			360 Degree Rotation					
		ABCDE+0	ABCDE+A	ABCDE+AB	0+0	A+0	ABC+0	ABCDE+0	ABCDE+A	ABCDE+AB
49.09	82.0			43,700						43,700
50	81.8			43,700						43,700
60	80.1			39,100						39,100
70	78.3			36,200						36,200
80	76.5			33,400						33,400
90	74.7			30,700						30,700
100	72.9			28,200						28,200
110	71.1			25,900						25,900
120	69.3			23,800						23,800
130	67.4			21,900						21,900
140	65.5			20,200						20,200
150	63.6	PROHIBITED		18,600	PROHIBITED					18,600
160	61.6			17,200						17,200
170	59.6			15,300						14,900
180	57.6			13,200						12,900
190	55.5			11,300						11,100
200	53.4			9,600						9,600
210	51.2			8,000						8,000
220	48.9			6,700						6,700
230	46.6			5,400						5,400
240	44.1			4,200						4,200
250	41.6		3,200					3,200		
260	38.9		2,200					2,200		

